

# Shenzhen DreamEagle Technology Co., Ltd.

E-mail:sales@skyhawkrc.com

Whatsapp: +8613510524210

<http://www.skyhawkrc.com>

No. 12, Wayao 4th Road, Wulian Community, Longgang Street, Longgang District, Shenzhen, Guangdong, China

## X4-30 Introduction



### Three-dimensional size

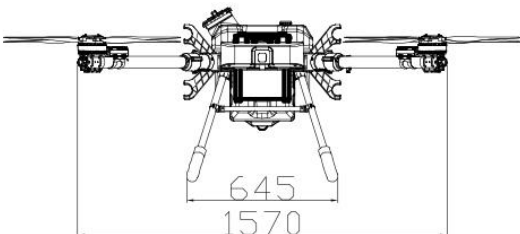
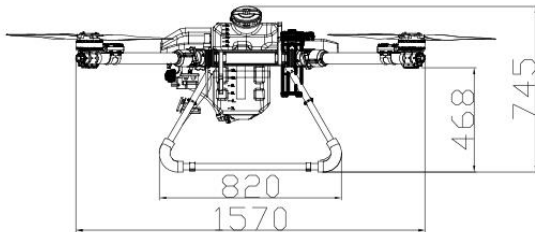
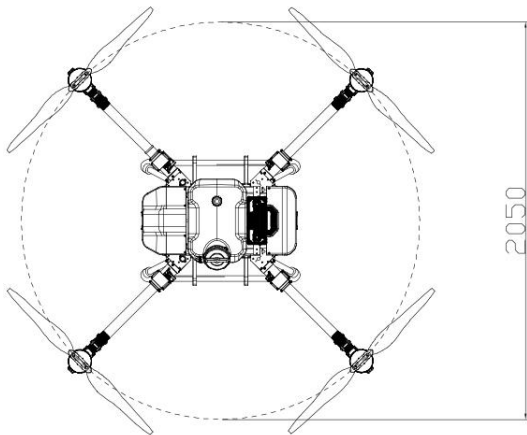

### Specifications

Expand Size: 1570x1570x805 mm

Folded size: 845x860x805 mm

Maximum wheelbase: 2050 mm

Arm size: 50mm carbon fiber tube

Medicine box volume: 30 L

Spreading box volume: 40 L

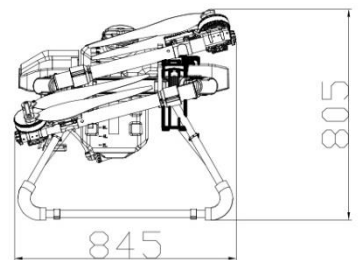
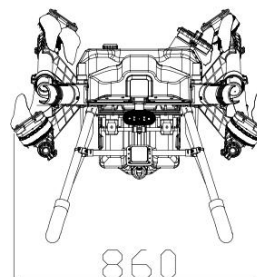

# Shenzhen DreamEagle Technology Co., Ltd.

E-mail: [sales@skyhawkrc.com](mailto:sales@skyhawkrc.com)

Whatsapp: +8613510524210

<http://www.skyhawkrc.com>

No. 12, Wayao 4th Road, Wulian Community, Longgang Street, Longgang District, Shenzhen, Guangdong, China

## Drone parameters

### Recommended configuration

- Flight control (optional)
- Power system: X11
- Battery: 14S 28000mAh

### Overall weight (without battery)

- 23-27 kg

### Maximum take-off weight

- Maximum spraying take-off weight: 64 kg (near sea level)
- Maximum spreading take-off weight: 74 kg (near sea level)

### Hover time

- Hover for 22 minutes with no load (@28000mAh & take-off weight 37 kg)
- Spray full load and hover for 10 minutes (@28000mAh & take-off weight 64 kg)
- Sowing and hovering for 9 minutes with full load (@28000mAh & take-off weight 74 kg)

### Maximum effective spray width

- 6-10 m (About 1.5-3 m from the crop height)

### Spraying method

- Down pressure spraying (4-8 nozzles, optional)
- Centrifugal spraying (4 nozzles, optional)

### Medicine box volume

- Full load 30L (working load, full load 30KG)

### Seeding box volume

- 40L (Internal maximum load, 40KG)

# Shenzhen DreamEagle Technology Co., Ltd.

E-mail: [sales@skyhawkrc.com](mailto:sales@skyhawkrc.com)

Whatsapp: +8613510524210

<http://www.skyhawkrc.com>

No. 12, Wayao 4th Road, Wulian Community, Longgang Street, Longgang District, Shenzhen, Guangdong, China

## Characteristic



X4-30 Agricultural Plant Protection Flying Platform



X4-30 Agricultural Plant Protection Spreading Platform

One machine multi-purpose platform (water mist, sowing)

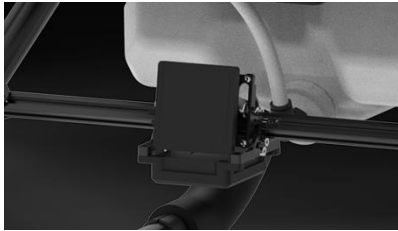

Worry-free installation of front, rear, left, right, up and down radar

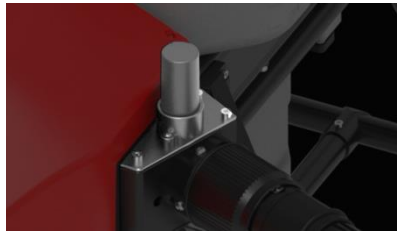

Support RTK installation



FPV module tail light installation

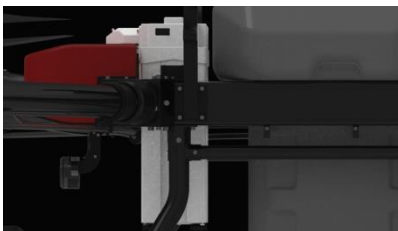

Quick release battery



Quick release water tank

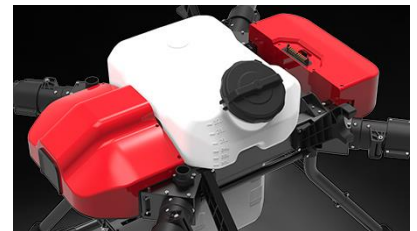

IP65 grade waterproof