

# X4-40 简介

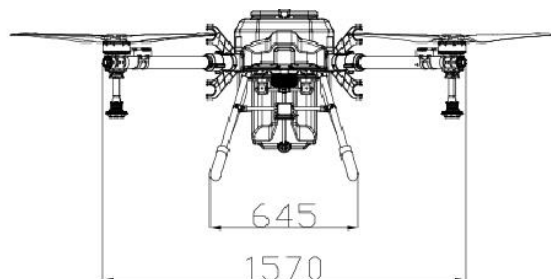

## 三维尺寸

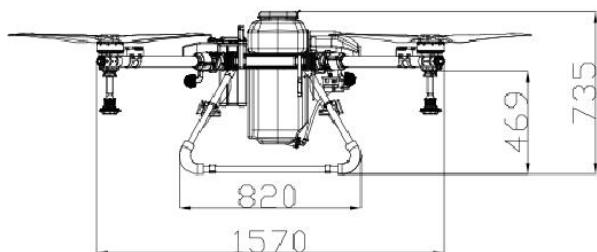
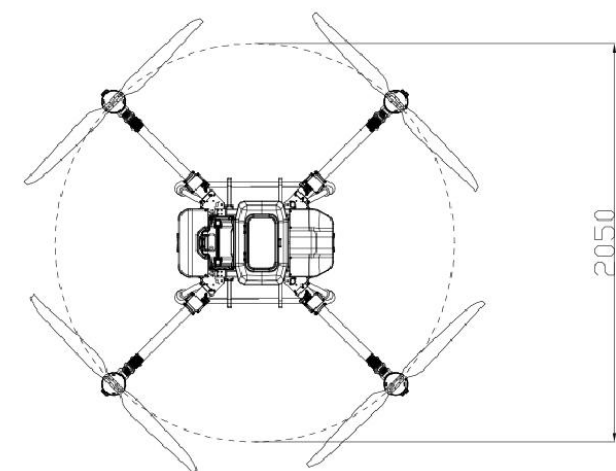

## 规格参数

展开尺寸: 1570x1570x735 mm

折叠尺寸: 845x860x810 mm

最大轴距: 2050 mm

机臂尺寸: 50mm 碳纤维管

药箱容积: 40 L

播撒箱容积: 50 L

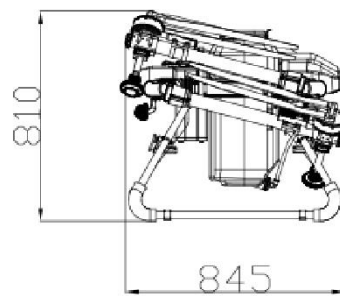
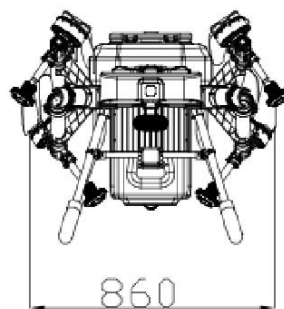

# 飞行器参数

## 推荐配置

- 飞控 (选配)
- 动力系统: X11 Max
- 电池: 18S 30000mAh

## 整机重量 (不含电池)

- 36~39 kg

## 最大起飞重量

- 最大喷洒起飞重量: 90 kg (海平面附近)
- 最大播撒起飞重量: 102 kg (海平面附近)

## 悬停时间

- 空载悬停 20min (@30000mAh & 起飞重量 51 kg)
- 喷洒满载悬停 7min (@30000mAh & 起飞重量 90 kg)
- 播撒满载悬停 6min (@30000mAh & 起飞重量 102 kg)

## 最大有效喷幅

- 11 m (距作物高度约 2.5-3 m, 飞行速度 7m/s)

## 喷洒方式

- 下压式喷洒 (4-8 个喷头, 选配)
- 离心式喷洒 (4 个喷头, 选配)

## 药箱容积

- 满载 40L (作业载荷, 满载 40KG)

## 播种作业箱容积

- 50L (内部最大载重, 50KG)

# 特性



X4-30 农业植保飞行平台



X4-40 农业植保飞行平台

## 载重飞行平台对比



前后左右上下雷达安装无忧



支持 RTK 安装

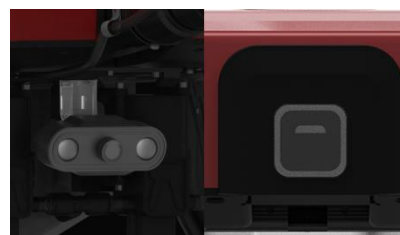

FPV 模块尾灯位安装



快拆电池



快拆水箱

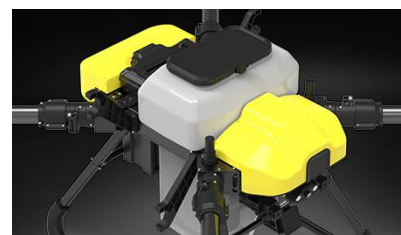

IP65 等级防水